

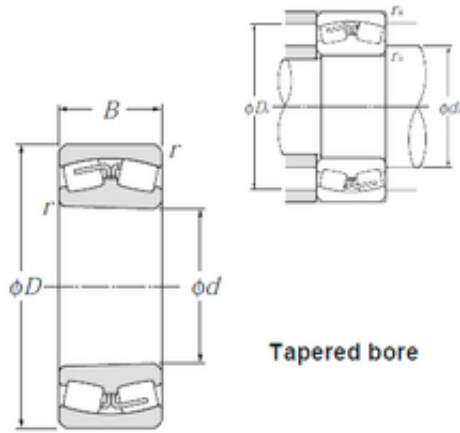

23288BK NTN Spherical Roller Bearings



Bearing No. 23288BK

23288BK Bearing 2D drawings and 3D CAD models

Size	440x790x280 mm
Bore Diameter	440 mm
Outer Diameter	790 mm
Width	280 mm
d	440 mm
D	790 mm
B	280 mm
C	280 mm
r min.	7,5 mm
da min.	476 mm
Da max.	754 mm
ra max.	6 mm
Weight	582 Kg
Basic dynamic load rating (C)	6 900 kN
Basic static load rating (C0)	12 800 kN
(Grease) Lubrication Speed	360 r/min
(Oil) Lubrication Speed	470 r/min
Calculation factor (e)	0,36
Calculation factor (Y0)	1,84
Calculation factor (Y1)	1,88