

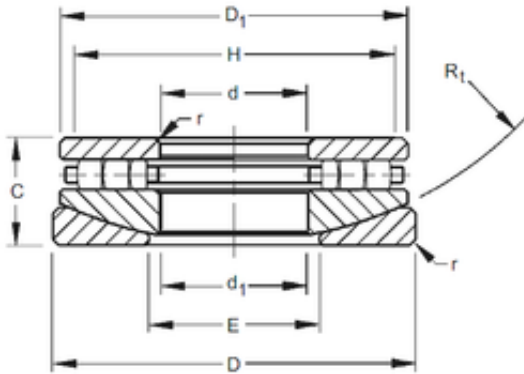

Timken 160TPS164 Thrust Cylindrical Roller Bearing



Bearing No. 160TPS164

Bore Diameter	406,4 mm
Outer Diameter	581,025 mm
d	406,4 mm
D	581,025 mm
r max	6,4 mm
d1	412,75 mm
C	152,4 mm
D1	555,62 mm
E	444,5 mm
H	539,8 mm
R	444,5 mm

160TPS164 Bearing 2D drawings and 3D CAD models