

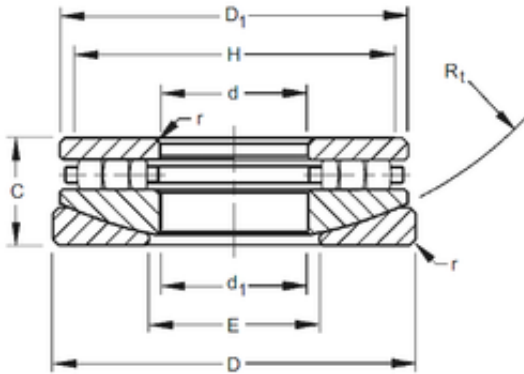

Timken 140TPS159 Thrust Cylindrical Roller Bearing



Bearing No. 140TPS159

Bore Diameter	355,6 mm
Outer Diameter	581,025 mm
d	355,6 mm
D	581,025 mm
r max	6,4 mm
d1	361,95 mm
C	123,825 mm
D1	555,62 mm
E	393,7 mm
H	535 mm
R	723,9 mm

140TPS159 Bearing 2D drawings and 3D CAD models