

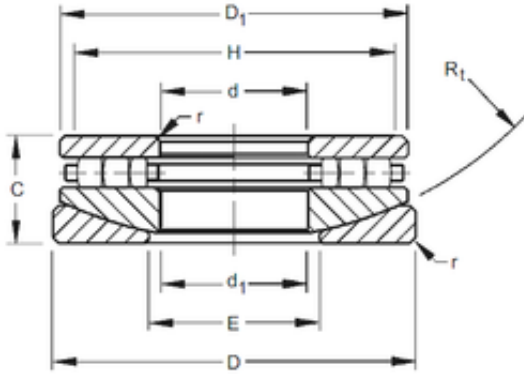

Timken 90TPS140 Thrust Cylindrical Roller Bearing



Bearing No. 90TPS140

Bore Diameter	228,6 mm
Outer Diameter	428,625 mm
d	228,6 mm
D	428,625 mm
r max	6,4 mm
d1	234,95 mm
C	101,6 mm
D1	404,02 mm
E	266,7 mm
H	385,8 mm
R	495,3 mm

90TPS140 Bearing 2D drawings and 3D CAD models