

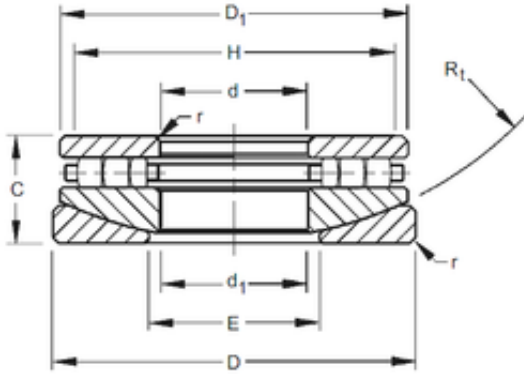

Timken 90TPS139 Thrust Cylindrical Roller Bearing



Bearing No. 90TPS139

Bore Diameter	228,6 mm
Outer Diameter	374,65 mm
d	228,6 mm
D	374,65 mm
r max	6,4 mm
d1	234,95 mm
C	101,6 mm
D1	353,22 mm
E	263,5 mm
H	339,7 mm
R	304,8 mm

90TPS139 Bearing 2D drawings and 3D CAD models