

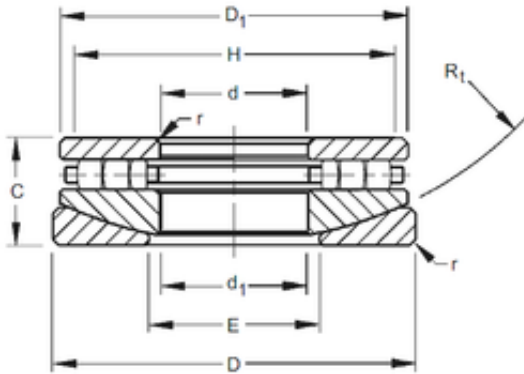

Timken 80TPS136 Thrust Cylindrical Roller Bearing



Bearing No. 80TPS136

Bore Diameter	203,2 mm
Outer Diameter	428,625 mm
d	203,2 mm
D	428,625 mm
r max	6,4 mm
d1	209,55 mm
C	101,6 mm
D1	404,02 mm
E	266,7 mm
H	382,6 mm
R	495,3 mm

80TPS136 Bearing 2D drawings and 3D CAD models