

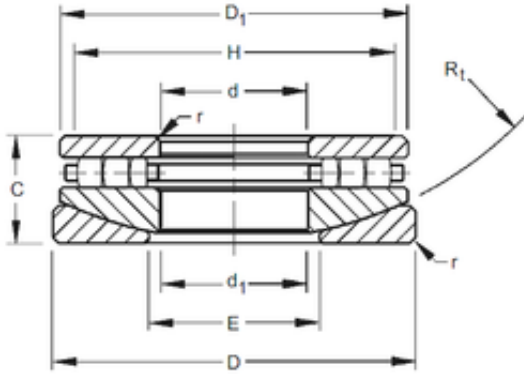

Timken 80TPS135 Thrust Cylindrical Roller Bearing



Bearing No. 80TPS135

Bore Diameter	203,2 mm
Outer Diameter	374,65 mm
d	203,2 mm
D	374,65 mm
r max	6,4 mm
d1	207,96 mm
C	101,6 mm
D1	353,22 mm
E	263,5 mm
H	336,6 mm
R	304,8 mm

80TPS135 Bearing 2D drawings and 3D CAD models