

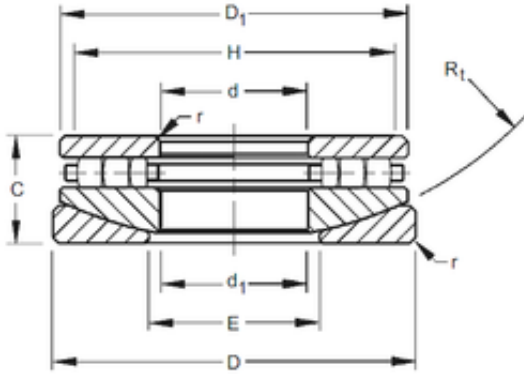

Timken 80TPS134 Thrust Cylindrical Roller Bearing



Bearing No. 80TPS134

Bore Diameter	203,2 mm
Outer Diameter	323,85 mm
d	203,2 mm
D	323,85 mm
r max	6,4 mm
d1	207,96 mm
C	101,6 mm
D1	302,42 mm
E	238,1 mm
H	292,1 mm
R	215,9 mm

80TPS134 Bearing 2D drawings and 3D CAD models