

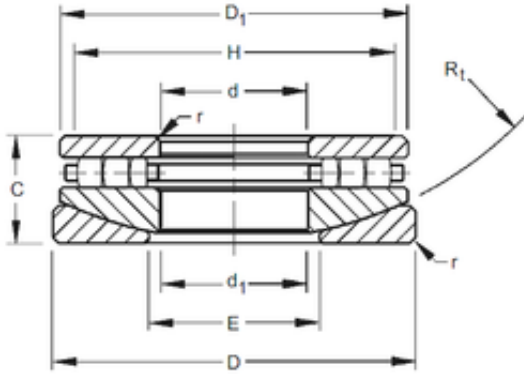

Timken 70TPS132 Thrust Cylindrical Roller Bearing



Bearing No. 70TPS132

Bore Diameter	177,8 mm
Outer Diameter	374,65 mm
d	177,8 mm
D	374,65 mm
r max	6,4 mm
d1	180,98 mm
C	101,6 mm
D1	353,22 mm
E	228,6 mm
H	335 mm
R	390,53 mm

70TPS132 Bearing 2D drawings and 3D CAD models