

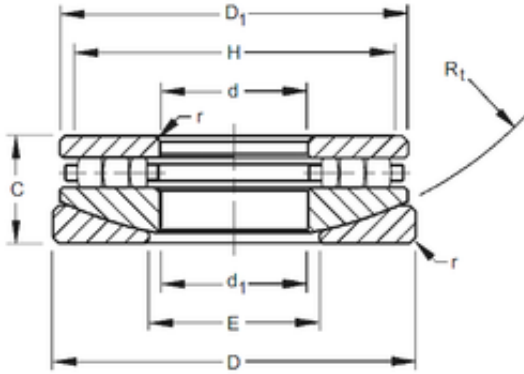

Timken 70TPS131 Thrust Cylindrical Roller Bearing



Bearing No. 70TPS131

Bore Diameter	177,8 mm
Outer Diameter	317,5 mm
d	177,8 mm
D	317,5 mm
r max	3,2 mm
d1	180,98 mm
C	66,675 mm
D1	302,42 mm
E	209,6 mm
H	288,9 mm
R	390,53 mm

70TPS131 Bearing 2D drawings and 3D CAD models