

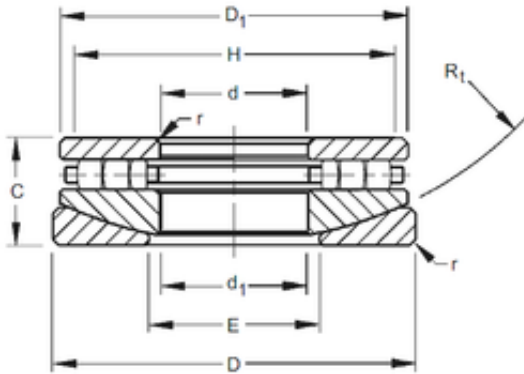

Timken 70TPS130 Thrust Cylindrical Roller Bearing



Bearing No. 70TPS130

Bore Diameter	177,8 mm
Outer Diameter	292,1 mm
d	177,8 mm
D	292,1 mm
r max	3,2 mm
d1	180,98 mm
C	66,675 mm
D1	277,02 mm
E	209,6 mm
H	266,7 mm
R	292,1 mm

70TPS130 Bearing 2D drawings and 3D CAD models