

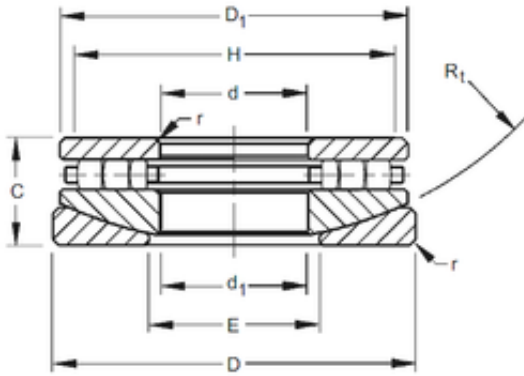

Timken 60TPS124 Thrust Cylindrical Roller Bearing



Bearing No. 60TPS124

Bore Diameter	152,4 mm
Outer Diameter	241,3 mm
d	152,4 mm
D	241,3 mm
r max	3,2 mm
d1	155,58 mm
C	66,675 mm
D1	227,01 mm
E	184,1 mm
H	217,5 mm
R	171,45 mm

60TPS124 Bearing 2D drawings and 3D CAD models