

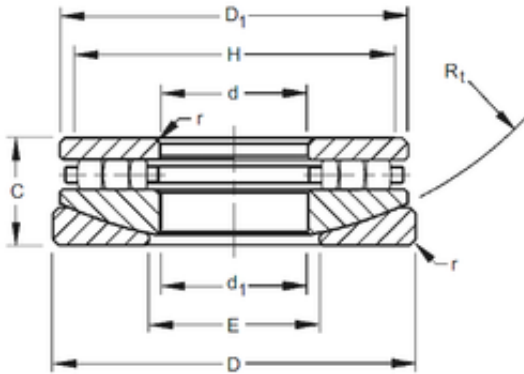

Timken 50TPS122 Thrust Cylindrical Roller Bearing



Bearing No. 50TPS122

Bore Diameter	127 mm
Outer Diameter	292,1 mm
d	127 mm
D	292,1 mm
r max	3,2 mm
d1	130,18 mm
C	66,675 mm
D1	277,81 mm
E	177,8 mm
H	261,9 mm
R	406,4 mm

50TPS122 Bearing 2D drawings and 3D CAD models