

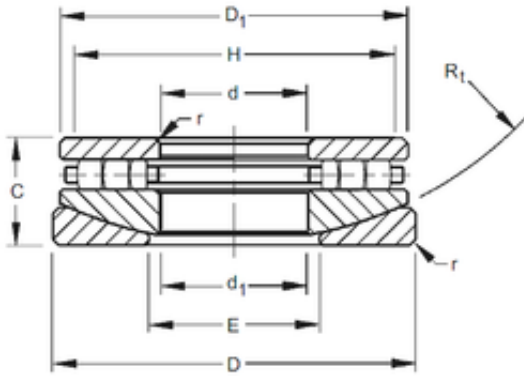

Timken 50TPS120 Thrust Cylindrical Roller Bearing



Bearing No. 50TPS120

Bore Diameter	127 mm
Outer Diameter	241,3 mm
d	127 mm
D	241,3 mm
r max	1,6 mm
d1	130,18 mm
C	58,738 mm
D1	227,01 mm
E	155,6 mm
H	215,9 mm
R	266,7 mm

50TPS120 Bearing 2D drawings and 3D CAD models