

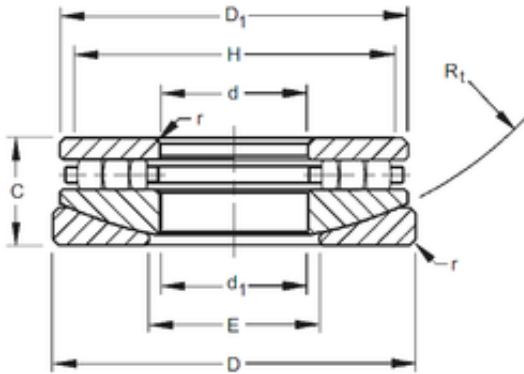

Timken 40TPS117 Thrust Cylindrical Roller Bearing



Bearing No. 40TPS117

Bore Diameter	101,6 mm
Outer Diameter	266,7 mm
d	101,6 mm
D	266,7 mm
r max	1,6 mm
d1	103,98 mm
C	58,738 mm
D1	252,41 mm
E	165,1 mm
H	238,1 mm
R	355,6 mm

40TPS117 Bearing 2D drawings and 3D CAD models