

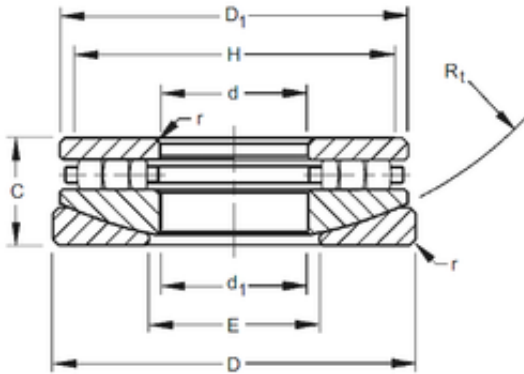

Timken 40TPS115 Thrust Cylindrical Roller Bearing



Bearing No. 40TPS115

Bore Diameter	101,6 mm
Outer Diameter	212,725 mm
d	101,6 mm
D	212,725 mm
r max	1,6 mm
d1	103,98 mm
C	58,738 mm
D1	201,61 mm
E	133,4 mm
H	190,5 mm
R	215,9 mm

40TPS115 Bearing 2D drawings and 3D CAD models