

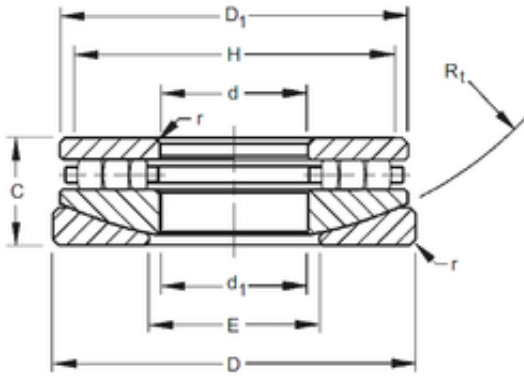

Timken 35TPS113 Thrust Cylindrical Roller Bearing



Bearing No. 35TPS113

Bore Diameter	88,9 mm
Outer Diameter	138,908 mm
d	88,9 mm
D	138,908 mm
r max	1,6 mm
d1	91,28 mm
C	33,338 mm
D1	130,97 mm
E	103,2 mm
H	123,8 mm
R	127 mm

35TPS113 Bearing 2D drawings and 3D CAD models