

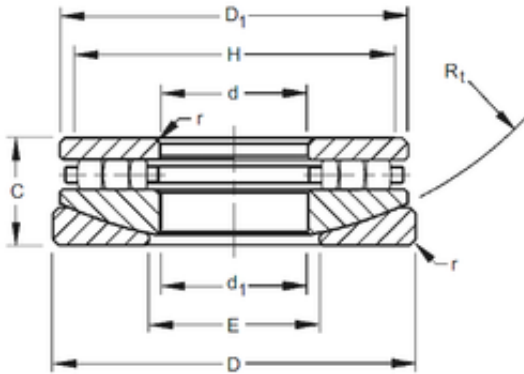

Timken 20TPS103 Thrust Cylindrical Roller Bearing



Bearing No. 20TPS103

Bore Diameter	50,8 mm
Outer Diameter	160,325 mm
d	50,8 mm
D	160,325 mm
r max	1,6 mm
d1	52,39 mm
C	46,038 mm
D1	150,81 mm
E	85,7 mm
H	141,3 mm
R	190,5 mm

20TPS103 Bearing 2D drawings and 3D CAD models