

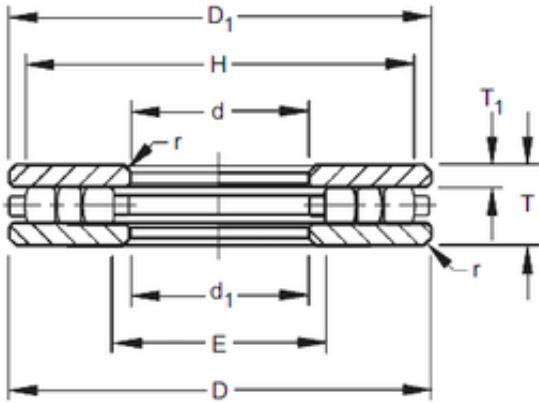

Timken 180TP170 Thrust Cylindrical Roller Bearing

Bearing No. 180TP170



180TP170 Bearing 2D drawings and 3D CAD models

Size	457.2x762x139.7 mm
Bore Diameter	457,2 mm
Outer Diameter	762 mm
Width	139,7 mm
d	457,2 mm
D	762 mm
T	139,7 mm
r max	6,4 mm
T1	38,1 mm
d1	460,4 mm
D1	758,8 mm
E	484,2 mm
H	735 mm