

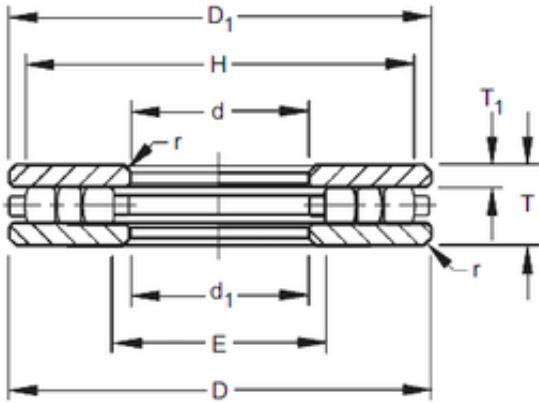

Timken 160TP165 Thrust Cylindrical Roller Bearing

Bearing No. 160TP165



160TP165 Bearing 2D drawings and 3D CAD models

Size	406.4x609.6x114.3 mm
Bore Diameter	406,4 mm
Outer Diameter	609,6 mm
Width	114,3 mm
d	406,4 mm
D	609,6 mm
T	114,3 mm
r max	6,4 mm
T1	31,75 mm
d1	409,6 mm
D1	606,4 mm
E	430,2 mm
H	585,8 mm