

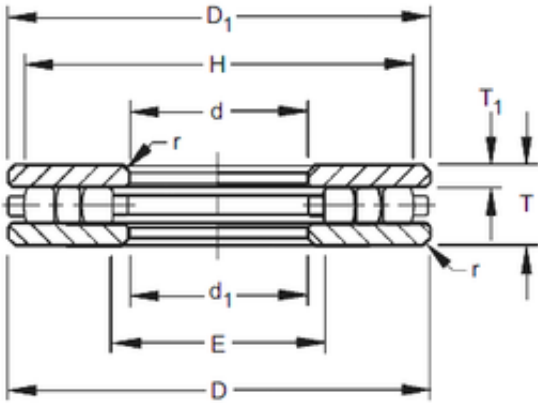

Timken 140TP160 Thrust Cylindrical Roller Bearing

Bearing No. 140TP160



140TP160 Bearing 2D drawings and 3D CAD models

Size	355.6x609.6x95.25 mm
Bore Diameter	355,6 mm
Outer Diameter	609,6 mm
Width	95,25 mm
d	355,6 mm
D	609,6 mm
T	95,25 mm
r max	6,4 mm
T1	26,19 mm
d1	358,78 mm
D1	606,4 mm
E	384,2 mm
H	581 mm