

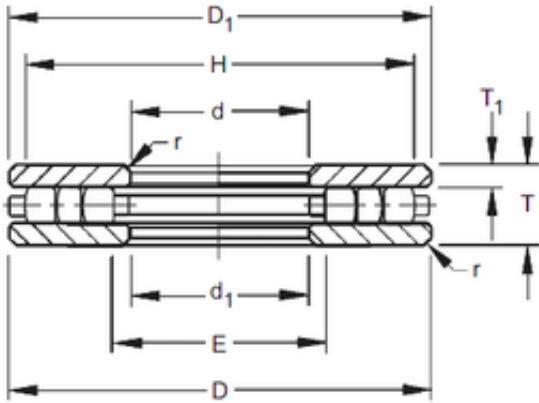

Timken 90TP139 Thrust Cylindrical Roller Bearing

Bearing No. 90TP139



90TP139 Bearing 2D drawings and 3D CAD models

Size	228.6x355.6x76.2 mm
Bore Diameter	228,6 mm
Outer Diameter	355,6 mm
Width	76,2 mm
d	228,6 mm
D	355,6 mm
T	76,2 mm
r max	6,4 mm
T1	20,64 mm
d1	230,98 mm
D1	353,22 mm
E	244,5 mm
H	339,7 mm