

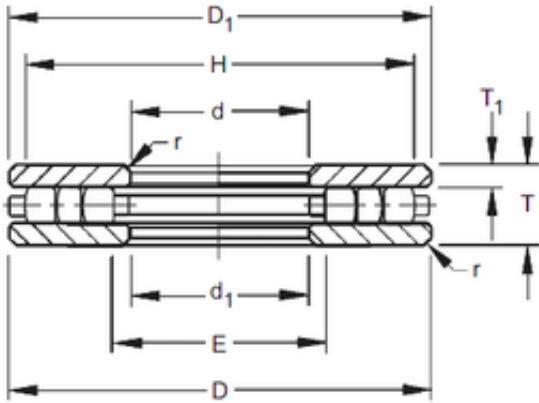

Timken 80TP135 Thrust Cylindrical Roller Bearing

Bearing No. 80TP135



80TP135 Bearing 2D drawings and 3D CAD models

Size	203.2x355.6x76.2 mm
Bore Diameter	203,2 mm
Outer Diameter	355,6 mm
Width	76,2 mm
d	203,2 mm
D	355,6 mm
T	76,2 mm
r max	6,4 mm
T1	20,64 mm
d1	205,58 mm
D1	353,22 mm
E	222,2 mm
H	336,6 mm