

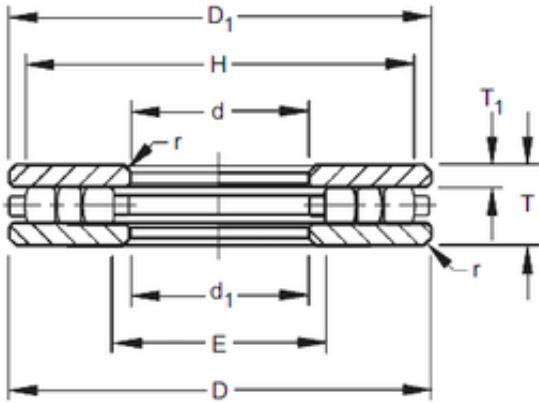

Timken 80TP134 Thrust Cylindrical Roller Bearing

Bearing No. 80TP134



80TP134 Bearing 2D drawings and 3D CAD models

Size	203.2x304.8x76.2 mm
Bore Diameter	203,2 mm
Outer Diameter	304,8 mm
Width	76,2 mm
d	203,2 mm
D	304,8 mm
T	76,2 mm
r max	6,4 mm
T1	20,64 mm
d1	205,58 mm
D1	302,42 mm
E	215,9 mm
H	292,1 mm