

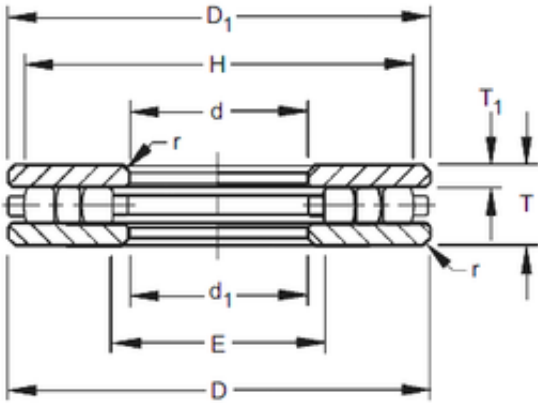

Timken 70TP129 Thrust Cylindrical Roller Bearing

Bearing No. 70TP129



70TP129 Bearing 2D drawings and 3D CAD models

Size	177.8x254x50.8 mm
Bore Diameter	177,8 mm
Outer Diameter	254 mm
Width	50,8 mm
d	177,8 mm
D	254 mm
T	50,8 mm
r max	3,2 mm
T1	14,29 mm
d1	180,18 mm
D1	251,62 mm
E	188,9 mm
H	242,9 mm