

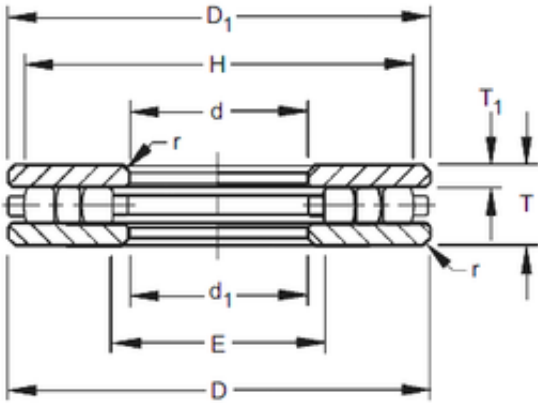

Timken 60TP127 Thrust Cylindrical Roller Bearing

Bearing No. 60TP127



60TP127 Bearing 2D drawings and 3D CAD models

Size	152.4x304.8x50.8 mm
Bore Diameter	152,4 mm
Outer Diameter	304,8 mm
Width	50,8 mm
d	152,4 mm
D	304,8 mm
T	50,8 mm
r max	3,2 mm
T1	14,29 mm
d1	153,99 mm
D1	303,31 mm
E	169,9 mm
H	287,3 mm