

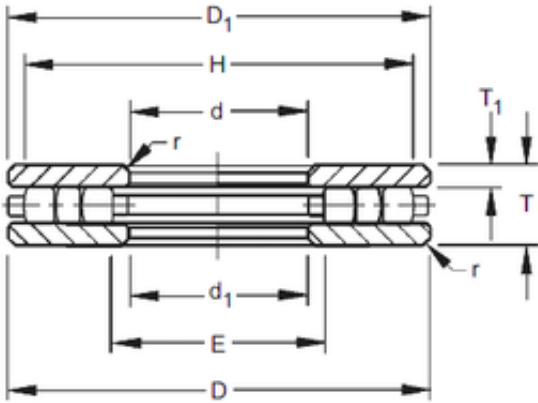

Timken 60TP126 Thrust Cylindrical Roller Bearing

Bearing No. 60TP126



60TP126 Bearing 2D drawings and 3D CAD models

Size	152.4x279.4x50.8 mm
Bore Diameter	152,4 mm
Outer Diameter	279,4 mm
Width	50,8 mm
d	152,4 mm
D	279,4 mm
T	50,8 mm
r max	3,2 mm
T1	14,29 mm
d1	153,99 mm
D1	277,81 mm
E	166,7 mm
H	265,1 mm