

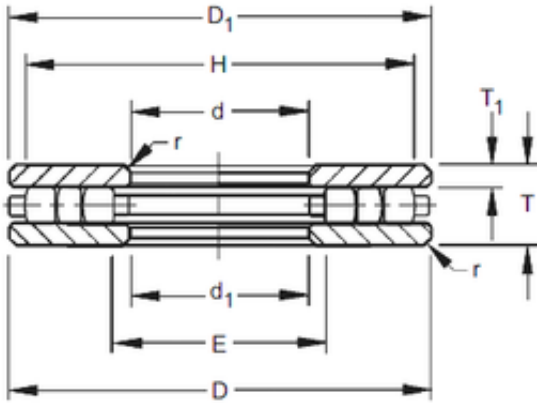

Timken 50TP119 Thrust Cylindrical Roller Bearing

Bearing No. 50TP119



50TP119 Bearing 2D drawings and 3D CAD models

Size	127x203.2x44.45 mm
Bore Diameter	127 mm
Outer Diameter	203,2 mm
Width	44,45 mm
d	127 mm
D	203,2 mm
T	44,45 mm
r max	1,6 mm
T1	12,7 mm
d1	128,59 mm
D1	201,61 mm
E	139,7 mm
H	190,5 mm