

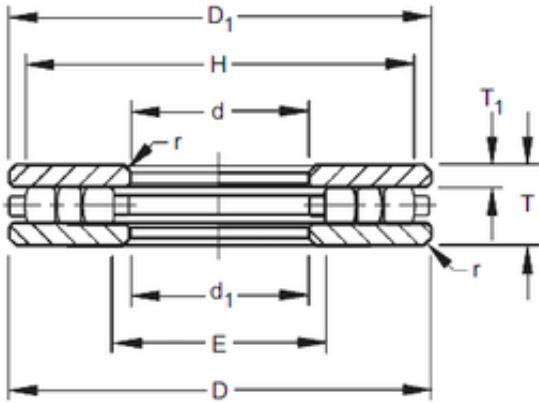

Timken 30TP109 Thrust Cylindrical Roller Bearing

Bearing No. 30TP109



30TP109 Bearing 2D drawings and 3D CAD models

Size	76.2x228.6x34.925 mm
Bore Diameter	76,2 mm
Outer Diameter	228,6 mm
Width	34,925 mm
d	76,2 mm
D	228,6 mm
T	34,925 mm
r max	1,6 mm
T1	9,52 mm
d1	77,79 mm
D1	227,01 mm
E	92,1 mm
H	212,7 mm