

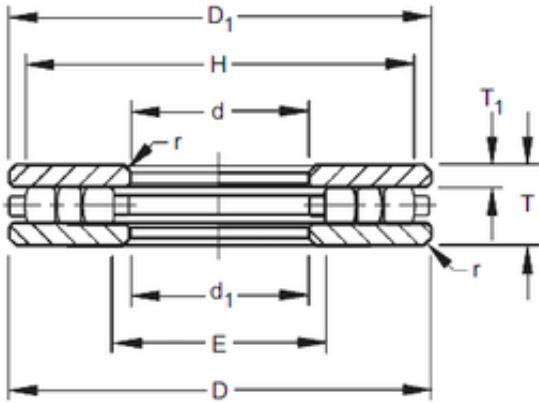

Timken 30TP107 Thrust Cylindrical Roller Bearing

Bearing No. 30TP107



30TP107 Bearing 2D drawings and 3D CAD models

Size	76.2x177.8x34.925 mm
Bore Diameter	76,2 mm
Outer Diameter	177,8 mm
Width	34,925 mm
d	76,2 mm
D	177,8 mm
T	34,925 mm
r max	1,6 mm
T1	9,52 mm
d1	77,79 mm
D1	176,21 mm
E	87,3 mm
H	166,7 mm