

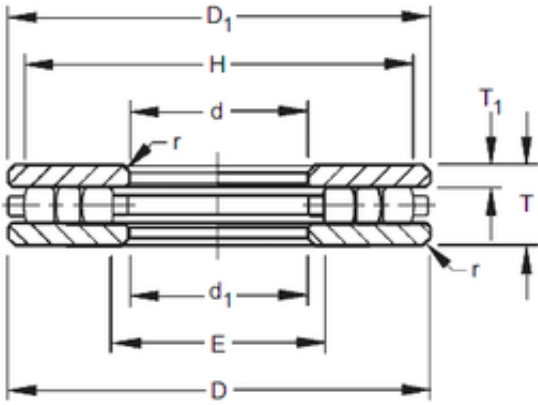

Timken 20TP103 Thrust Cylindrical Roller Bearing

Bearing No. 20TP103



20TP103 Bearing 2D drawings and 3D CAD models

Size	50.8x152.4x34.925 mm
Bore Diameter	50,8 mm
Outer Diameter	152,4 mm
Width	34,925 mm
d	50,8 mm
D	152,4 mm
T	34,925 mm
r max	1,6 mm
T1	9,52 mm
d1	52,39 mm
D1	150,81 mm
E	61,9 mm
H	141,3 mm