

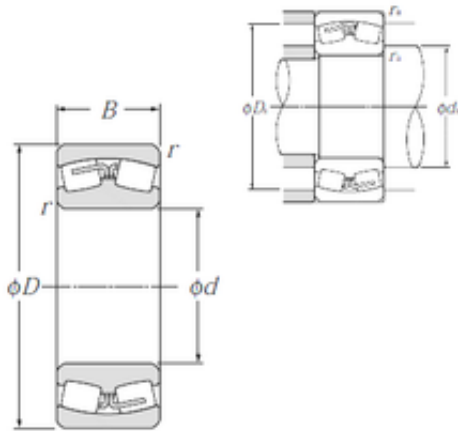

750 mm x 1 360 mm x 475 mm NTN 232/750B  
Spherical Roller Bearings



Bearing No. 232/750B

232/750B Bearing 2D drawings and 3D CAD models

Size	750x1360x475 mm
Bore Diameter	750 mm
Outer Diameter	1360 mm
Width	475 mm
d	750 mm
D	1 360 mm
B	475 mm
C	475 mm
r min.	15 mm
da min.	814 mm
Da max.	1 296 mm
ra max.	12 mm
Weight	3 050 Kg
Basic dynamic load rating (C)	18 200 kN
Basic static load rating (C0)	36 500 kN
(Grease) Lubrication Speed	180 r/min
(Oil) Lubrication Speed	240 r/min
Calculation factor (e)	0,35
Calculation factor (Y0)	1,88
Calculation factor (Y1)	1,92